



Spec. No.: MDGD084-SN05-3

Version: 0.2

Total pages: 25

Date: 2006- Jun-1

# AU OPTRONICS CORPORATION

## Product Functional Specifications

### 8.4" SVGA Color TFT-LCD Module

### Model Name: G084SN05 v.3

Approved by	Prepared by
Peter ML Lee	TH Lu

*GDBD Marketing Division / AU Optronics Corporation*

Customer	Checked & Approved by



**Version: 0.2**

**Total Pages: 25**

**Date: 2006/06/01**

## Product Functional Specification

8.4 inch SVGA Color TFT LCD Module  
Model Name: G084SN05 V.3

Preliminary Specification  
 Final Specification

Note: This Specification is subject to change without notice.



## **I. Contents**

<b>1.0</b>	<b>Handling Precautions</b> .....	<b>5</b>
<b>2.0</b>	<b>General Description</b> .....	<b>6</b>
2.1	Display Characteristics	
2.2	Functional Block Diagram	
<b>3.0</b>	<b>Absolute Maximum Ratings</b> .....	<b>8</b>
<b>4.0</b>	<b>Optical Characteristics</b> .....	<b>9</b>
<b>5.0</b>	<b>Signal Interface</b> .....	<b>11</b>
5.1	Connectors	
5.2	Signal Pin	
5.3	Signal Description	
5.4	Signal Electrical Characteristics	
5.5	Signal for Lamp Connector	
<b>6.0</b>	<b>Pixel Format Image</b> .....	<b>15</b>
<b>7.0</b>	<b>Parameter Guide Line CCFL Inverter</b> .....	<b>16</b>
<b>8.0</b>	<b>Interface Timing</b> .....	<b>17</b>
8.1	Timing Characteristics	
8.2	Timing Definition	
8.3	Timing Chart	
<b>9.0</b>	<b>Power Consumption</b> .....	<b>20</b>
<b>10.0</b>	<b>Power ON/OFF Sequence</b> .....	<b>21</b>
<b>11.0</b>	<b>Reliability Test Items</b> .....	<b>22</b>
<b>12.0</b>	<b>Packing Dimension</b> .....	<b>23</b>
<b>13.0</b>	<b>Mechanical Characteristics</b> .....	<b>24</b>



## II. Record of Revision

Version and Date	Page	Old Description	New Description	Remark
0. 2006/02/27	All	First Draft	All	
0.2 2006/06/01	16	N/A	Add the spec of lamp life(min)	
	16	Note 1, 2, 3,4 and 5	Modify and restructure the description of Note	
	16	PCFL Min: 2.18, Typ: 2.4, Max: 2.64	PCFL Min: 4.36, Typ: 4.8, Max: 5.28	
	16	Condition of Lamp life: Note2	Condition of Lamp life: Note2 IRCFL = 6mA	
	16	Note 1 and 2	Modify Note 1 and 2	
	6, 8, 9, 16, 17	Symbol: ICFL	Symbol: IRCFL	



## 1.0 Handling Precautions

- 1) Since front polarizer is easily damaged, pay attention not to scratch it.
- 2) Be sure to turn off power supply when inserting or disconnection from input connector.
- 3) Wipe off water drop immediately. Long contact with water may cause discoloration or spots.
- 4) When the panel surface is soiled, wipe it with absorbent cotton or other soft cloth.
- 5) Since the panel is made of glass, it may break or crack if dropped or bumped on hard surface.
- 6) Since CMOS LSI is used in this module, take care of static electricity and insure human earth when handling.
- 7) Do not open nor modify the module Assembly.
- 8) Do not press the reflector sheet at the back of the module to any directions.
- 9) In case if a module has to be put back into the packing container slot after once it was taken out from the container, do not press the center of the CCFL Reflector edge. Instead, press at the far ends of the CFL Reflector edge softly. Otherwise the TFT module may be damaged.
- 10) At the insertion or removal of the Signal Interface Connector, be sure not to rotate nor tilt the interface Connector of the TFT module.
- 11) After installation of the TFT module into an enclosure, do not twist nor bend the TFT module even momentary. At designing the enclosure, it should be taken into consideration that no bending/twisting forces are applied to the TFT module from outside. Otherwise the TFT module may be damaged.
- 12) Cold cathode fluorescent lamp in LCD contains a small amount of mercury. Please follow local ordinances or regulations for disposal.
- 13) Small amount of materials having no flammability grade is used in the LCD module should be supplied by power complied with requirements of Limited Power Source, or be applied exemption.
- 14) The LCD module is designed so that the CFL in it is supplied by Limited Current Circuit. Do not connect the CFL in Hazardous Voltage Circuit.



## 2.0 General Description

This specification applies to the 8.4 inch color TFT LCD module G084SN05 V.0.

This module is designed for display units for Industrial Applications.

The screen format is intended to support the SVGA (800(H) x 600(V)) screen and 262k colors (RGB 6-bits data driver).

All input signals are LVDS interface compatible.

The module does not contain an inverter card for backlight.

This is an RoHs product.

## 2.1 Display Characteristics

The following items are characteristics summary on the table under 25°C condition :

Items	Unit	Specifications
Screen Diagonal	[mm]	213.4 ( 8.4")
Active Area	[mm]	170.4(H) x 127.8(V)
Pixel H x V		800(x3) x 600
Pixel Pitch	[mm]	0.213(H) x 0.213(V)
Pixel Arrangement		R.G.B. Vertical Stripe
Display Mode		Normally White
Typical White Luminance (ICFL=6 mA)	[cd/m <sup>2</sup> ]	450 Typ. (center)
Contrast Ratio		500 : 1 Typ.
Optical Rise Time/Fall Time	[msec]	10/25 Typ.
Nominal Input Voltage VDD	[Volt]	+3.3 Typ.
Typical Power Consumption (VDD line + VCFL line)	[Watt]	5.8 Typ
Weight	[Grams]	260 ±10
Physical Size	[mm]	203.0(W) x 142.5(H) x 8.0(D)
Electrical Interface		LVDS
Support Color		Native 262K colors (RGB 6-bit driver)
Temperature Range		
Operating	[°C]	0 to +50
Storage(Shipping)	[°C]	-20 to +60

## 2.2 Functional Block Diagram

The following diagram shows the functional block of the 8.4 inches Color TFT LCD Module :

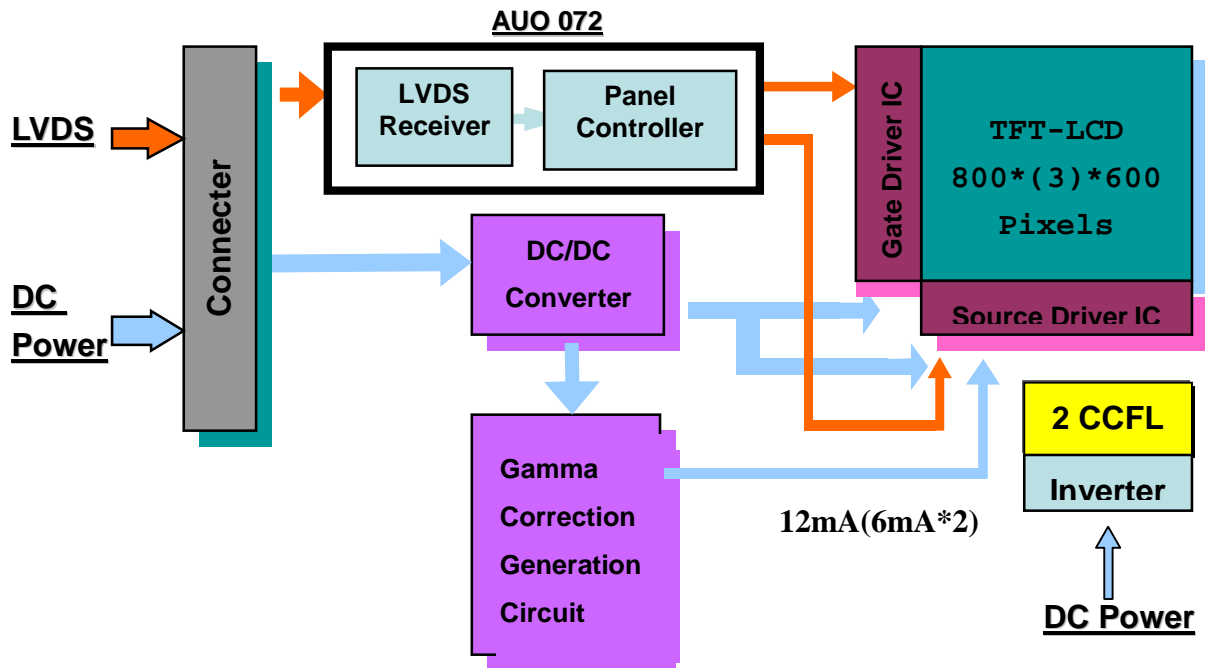



### 3.0 Absolute Maximum Ratings

Absolute maximum ratings of the module is as follows :

Item	Symbol	Min	Max	Unit	Conditions
Logic/LCD Drive Voltage	VDD	-0.3	+6.0	[Volt]	
Input Voltage of Signal	Vin	-0.3	VDD+0.3	[Volt]	
CCFL Current	ICFL	4	7	[mA] rms	
CCFL Ignition Voltage	Vs	-	670	Vrms	25°C
			870		0°C
Operating Temperature	TOP	0	+50	[°C]	Note1
Operating Humidity	HOP	8	95	[%RH]	Note1
Storage Temperature	TST	-20	+60	[°C]	Note1
Storage Humidity	HST	5	95	[%RH]	Note1

**Note1** : Maximum Wet-Bulb should be 39°C and no condensation.

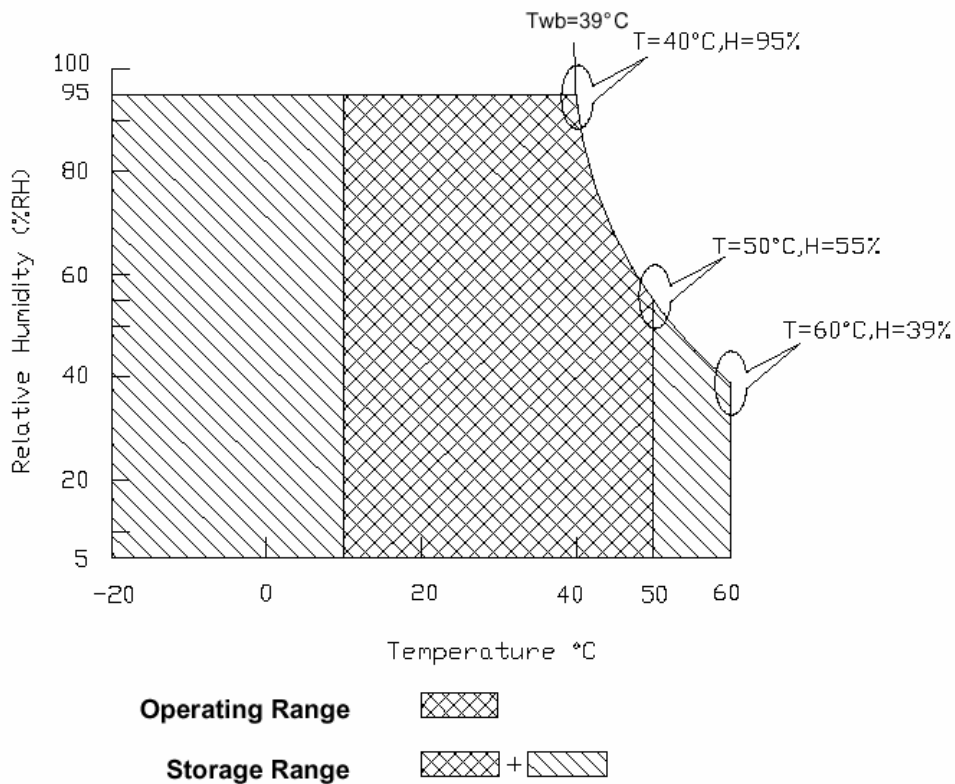





## 4.0 Optical Characteristics

The optical characteristics are measured under stable conditions as follows under 25°C condition :

Item	Unit	Conditions	Min.	Typ.	Max.
Viewing Angle	[degree]	Horizontal (Right)	—	60	—
K : Contrast ratio	[degree]	K = 10 (Left)		60	
	[degree]	Vertical (Upper)	—	60	—
	[degree]	K = 10 (Lower)		40	
White Uniformity		9 Points	—	—	1.6
Contrast ratio		$\theta = 0^\circ$	400	500	—
Response Time (Room Temp)	[msec]	Rising	—	10	20
	[msec]	Falling	—	25	30
Color Chromaticity Coordinates(CIE)		Red x	0.53	0.56	0.59
		Red y	0.29	0.32	0.35
		Green x	0.27	0.3	0.33
		Green y	0.52	0.55	0.58
		Blue x	0.12	0.15	0.18
		Blue y	0.09	0.12	0.15
		White x	0.28	0.31	0.34
		White y	0.3	0.33	0.36
White Luminance (ICFL 6mA)	[cd/m <sup>2</sup> ]	$\theta = 0^\circ$	350	450	—



**Note 1: Definition of white uniformity:**

White uniformity is calculated with the following formula.  
Luminance are measured at the following nine points (1~9).

$$\delta_w = \frac{\text{Maximum Brightness of nine points}}{\text{Minimum Brightness of nine points}}$$

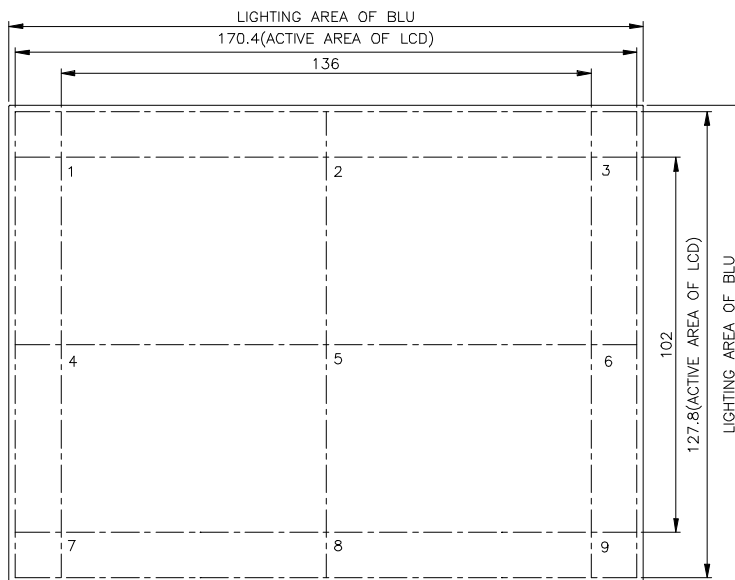



## 5.0 Signal Interface

### 5.1 Connectors

Physical interface is described as for the connector on module.

These connectors are capable of accommodating the following signals and will be following components.

Connector Name / Designation	For Signal Connector
Manufacturer	HIROSE
Type / Part Number	HRS DF 19K-20P-1H or compatible
Mating Connector / Part Number	HRS DF19G-20S-1C (WIRE TYPE)
Mating Connector / Part Number	HRS DF19-20S-1F (FPC TYPE)

Connector Name / Designation	For Lamp Connector
Manufacturer	JST
Type / Part Number	JST BHR-03VS-1 or compatible
Mating Connector / Part Number	JST SM03(4.0)B-BHS-1-TB

### 5.2 Signal Pin

Pin No.	Signal Name	Pin No.	Signal Name
1	VDD	2	VDD
3	GND	4	GND
5	RxIN0-	6	RxIN0+
7	GND	8	RxIN1-
9	RxIN1+	10	GND
11	RxIN2-	12	RxIN2+
13	GND	14	CKIN-
15	CKIN+	16	GND
17	NC	18	NC
19	GND	20	GND



## 5.3 Signal Description

The module using a LVDS receiver. LVDS is a differential signal technology for LCD interface and high speed data transfer device. Transmitter shall be SN75LVDS84 (negative edge sampling) or compatible.

Signal Name	Description
RxIN0-, RxIN0+	LVDS differential data input (Red0-Red5, Green0)
RxIN1-, RxIN1+	LVDS differential data input (Green1-Green5, Blue0-Blue1)
RxIN2-, RxIN2+	LVDS differential data input (Blue2-Blue5, Hsync, Vsync, DE)
CKIN-, CKIN+	LVDS differential clock input
VDD	+3.3V Power Supply
GND	Ground
NC	No Connection

**Note** : Input signals shall be low or Hi-Z state when VDD is off.



Signal Name	Description	
+RED5 +RED4 +RED3 +RED2 +RED1 +RED0	Red Data 5 (MSB) Red Data 4 Red Data 3 Red Data 2 Red Data 1 Red Data 0 (LSB) Red-pixel Data	Red-pixel Data Each red pixel's brightness data consists of these 6 bits pixel data.
+GREEN5 +GREEN4 +GREEN3 +GREEN2 +GREEN1 +GREEN0	Green Data 5 (MSB) Green Data 4 Green Data 3 Green Data 2 Green Data 1 Green Data 0 (LSB) Green-pixel Data	Green-pixel Data Each green pixel's brightness data consists of these 6 bits pixel data.
+BLUE5 +BLUE4 +BLUE3 +BLUE2 +BLUE1 +BLUE0	Blue Data 5 (MSB) Blue Data 4 Blue Data 3 Blue Data 2 Blue Data 1 Blue Data 0 (LSB) Blue-pixel Data	Blue-pixel Data Each blue pixel's brightness data consists of these 6 bits pixel data.
CLK	Data Clock	The typical frequency is 40MHz. The signal is used to strobe the pixel data and DE signals. All pixel data shall be valid at the falling edge when the DE signal is high.
DE	Display Timing	This signal is strobed at the falling edge of CLK. When the signal is high, the pixel data shall be valid to be displayed.
VSYNC	Vertical Sync	The signal is synchronized to CLK.
HSYNC	Horizontal Sync	The signal is synchronized to CLK.

**Note** : Output signals from any system shall be low or Hi-Z state when VDD is off.

## 5.4 Signal Electrical Characteristics

Input signals shall be low or Hi-Z state when VDD is off.

It is recommended to refer the specifications of SN75LVDS86(Texas Instruments) in detail.

Signal electrical characteristics are as follows :

Item	Symbol	Min.	Typ.	Max.	Unit
The differential level	$ V_{ID} $	0.1	-	0.6	V
The common mode input voltage	VIC	$\frac{ V_{ID} }{2}$	-	$2.4 - \frac{ V_{ID} }{2}$	V
The input setup time	tsu	0.5	-	-	ns
The input hold time	thd	0.5	-	-	ns
High-level input voltage	V <sub>IAP</sub>	2.0			V
Low-level input voltage	V <sub>IAM</sub>			0.8	V
Clock frequency	CLK	31		68	MHz

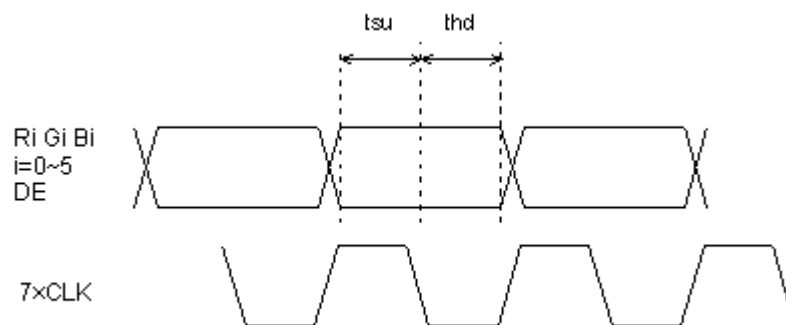
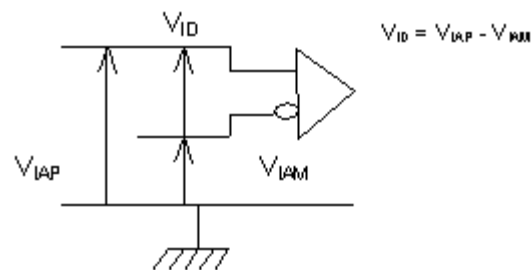



## 5.5 Signal for Lamp connector

**Note:** CN2 connector (backlight): JST BHR-03VS-1

Mating connector: JST SM03(4.0)B-BHS-1-TB

Pin no.	Symbol	Function	Remark
1	H	CCFL power supply (H.V.)	Cable color: Pink
2	NC	No connection	
3	L	CCFL power supply (GND)	Cable color: White

## 6.0 Pixel Format Image

Following figure shows the relationship of the input signals and LCD pixel format :

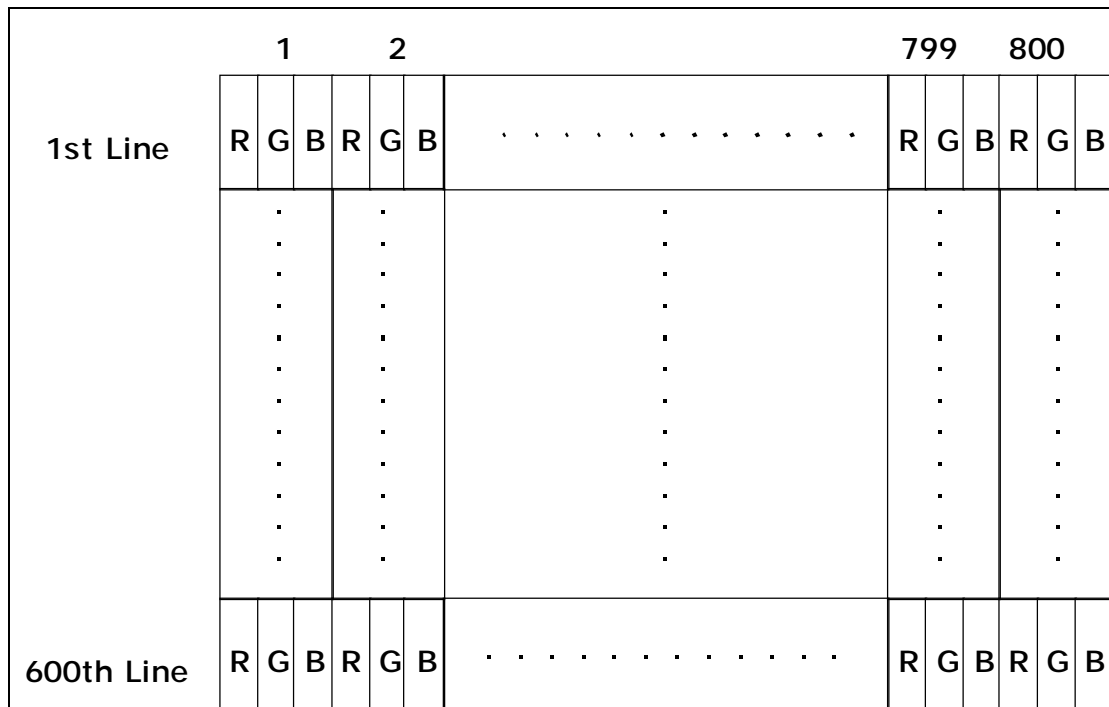

## 7.0 Parameter guide line for CCFL

Symbol	Parameter	Min	Typ	Max	Units	Condition
ICFL (25°C)	CCFL operation range	4	6	7	mArms	Note1.2
FCFL	CCFL Frequency	40	55	80	KHz	Note3
ViCFL (0°)	CCFL Ignition Voltage			870	Vrms	
ViCFL (25°C)	CCFL Ignition Voltage	-	-	670	Vrms	
VCFL	CCFL Discharge Voltage	363.6	400	440	Vrms	Note4
PCFL	CCFL Power consumption	2.18	2.4	2.64	W	Note4
Lamp Life		40,000	50,000	-	Hrs	Note2

**Note 1 :** ICFL is defined as the return current of an inverter. (In Fig.1)

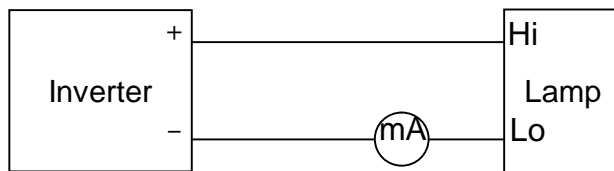

(Fig. 1: Measurement of return current)

A stable ICFL is the a current without flicker or biasing waveform provide by inverter that ensures the backlight perform to its specification. The ideal sine wave form should be symmetric in the positive and negative polarities and the asymmetry rate of the inverter waveform should be below 10%.

Concerning the leakage from inverter, ICFL is recommended not to exceed 6.0mA for CCFL life time concern and it is prohibited to exceed 7.0mA.

It is recommended to use the inverter with detection circuir to avoid overvoltage, overcurrent, or mismatching waveform. The purpose is to avoid current flow into onlt one of the lamps when the other one is not in operation.

**Note 2 :** The life time is defined as when the brightness of CCFL is reduced by half. Due to the leakage generated from LCD panel and inverter, the minimum lamp life is defined as the input current equals 7mA. Different inverter design will result in different input current, leakage, and further impact the lamp life.

**Note 3 :** CCFL frequency should be carefully determined to avoid interference between inverter and TFT LCD.

**Note 4 :** Calculator value for reference (ICFL\*VCFL\*2=PCFL )





## 8.0 Interface Timings

Basically, interface timing should match the VESA 800x600 /60Hz(VG901101) manufacturing guide line timing.

### 8.1 Timing Characteristics

(a) DE mode

Item	Symbol	Min.	Typ.	Max.	Unit	Remark
Clock frequency	Fck	38	40	48	MHz	
Horizontal blanking	Thb1	50	256	500	Clk	
Vertical blanking	Tvb1	10	28	150	Th	

(b) HV mode

Item	Symbol	Min.	Typ.	Max.	Unit	Remark
Clock frequency	Fck	38	40	48	MHz	
Hsync period	Th	850	1056	1300	Clk	
Hsync pulse width	Thw	10	128	-	Clk	
Hsync front porch	Thf	15	40	-	Clk	
Hsync back porch	Thb	10	88	-	Clk	
Hsync blanking	Thb1	50	256	500	Clk	
Vsync period	Tv	610	628	750	Th	
Vsync pulse width	Tvw	1	4	-	Th	
Vsync front porch	Tvf	0	1	-	Th	
Vsync blanking	Tvb1	10	28	150	Th	
Hsync/Vsync phase shift	Tvpd	2	320	-	Clk	

Item	Symbol	Value	Unit	Description
Horizontal display start	The	218	Clk	After falling edge of Hsync, counting 218clk, then getting valid data from 219th clk's data.
Vertical display start	Tve	25	Th	After falling edge of Vsync, counting 25th, then getting 26th Th's data.

## 8.2 Timing Definition

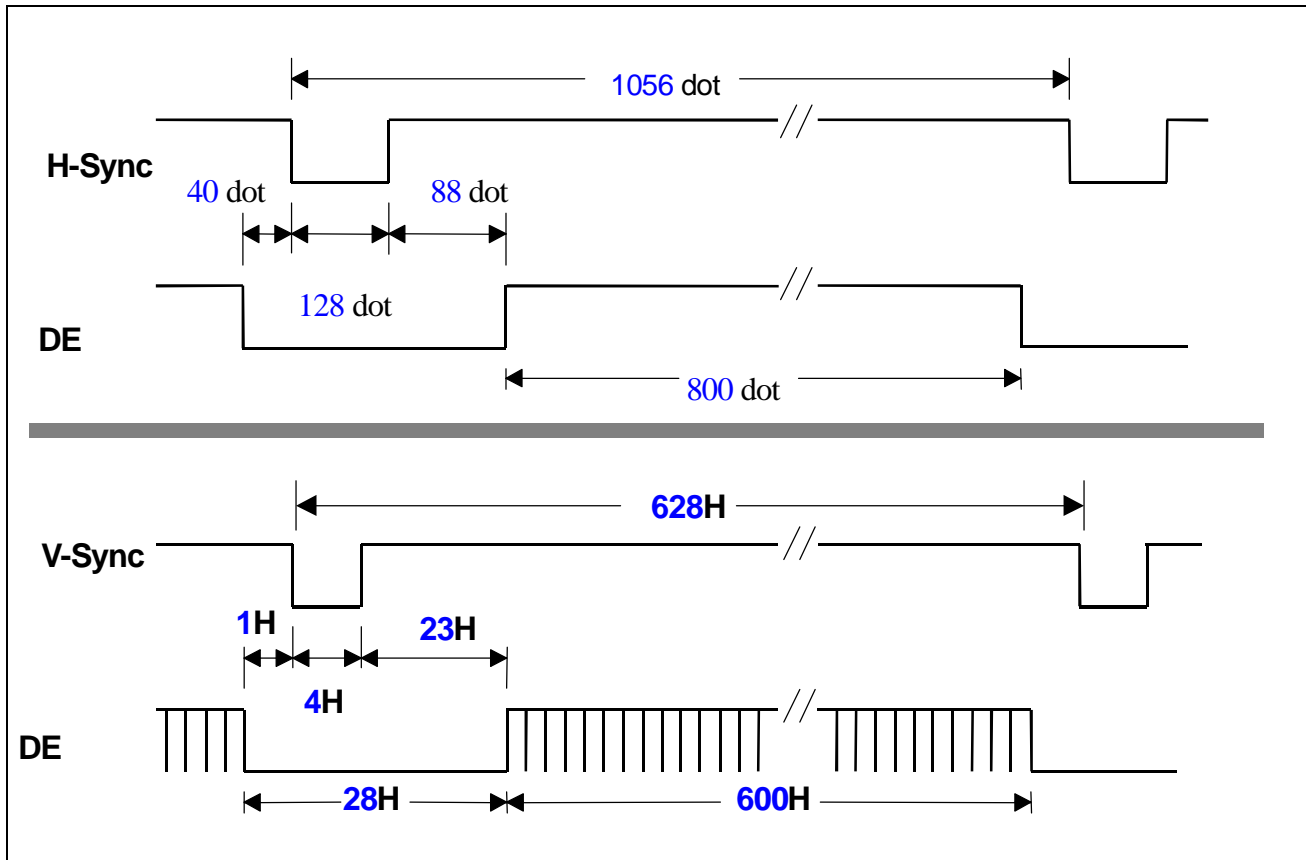



### 8.3 Timing Chart

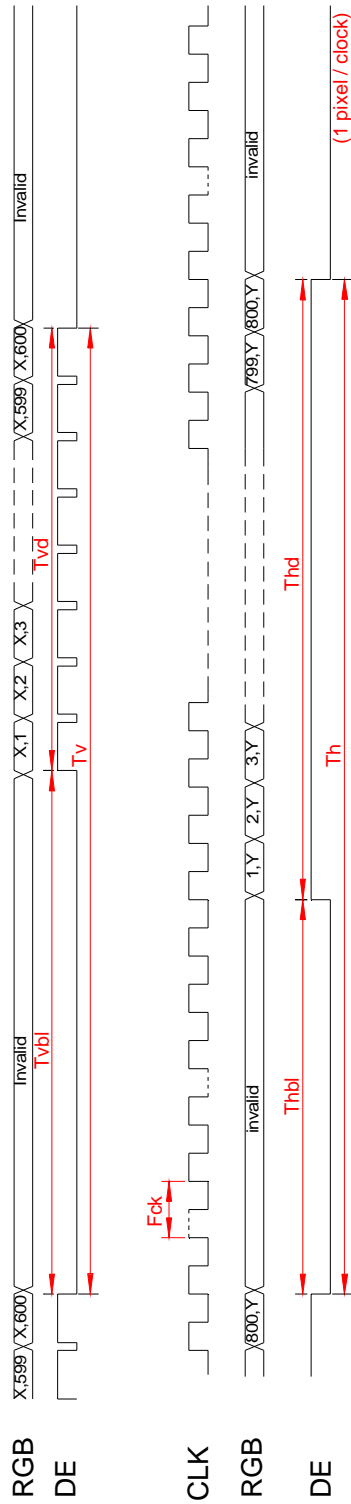



## 9.0 Power Consumption

Input power specifications are as follows :

Symbol	Parameter	Min	Typ	Max	Units	Condition
VDD	Logic/LCD Drive Voltage	3.0	3.3	3.6	V	
PDD	VDD Power	-	0.76	-	W	
PDD Max	VDD Power max	-	0.86	-	W	
IDD	IDD Current	-	230	-	mArms	Note 1
IDD Max	IDD Current max	-	260	-	mArms	Note 2
V <sub>RP</sub>	Power Ripple Voltage	-	100	-	mVp-p	
I <sub>RUSH</sub>	Inrush Current	-	1500	-	mApeak	

**Note 1:** Effective value (mArms) at  $V_{CC} = 3.3\text{ V}/25^{\circ}\text{C}$ .

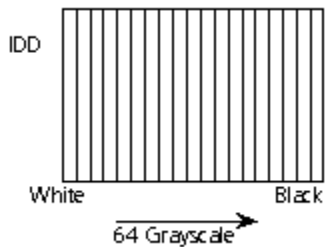

**Note 2:**

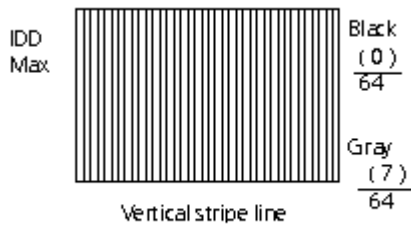



## 10.0 Power ON/OFF Sequence

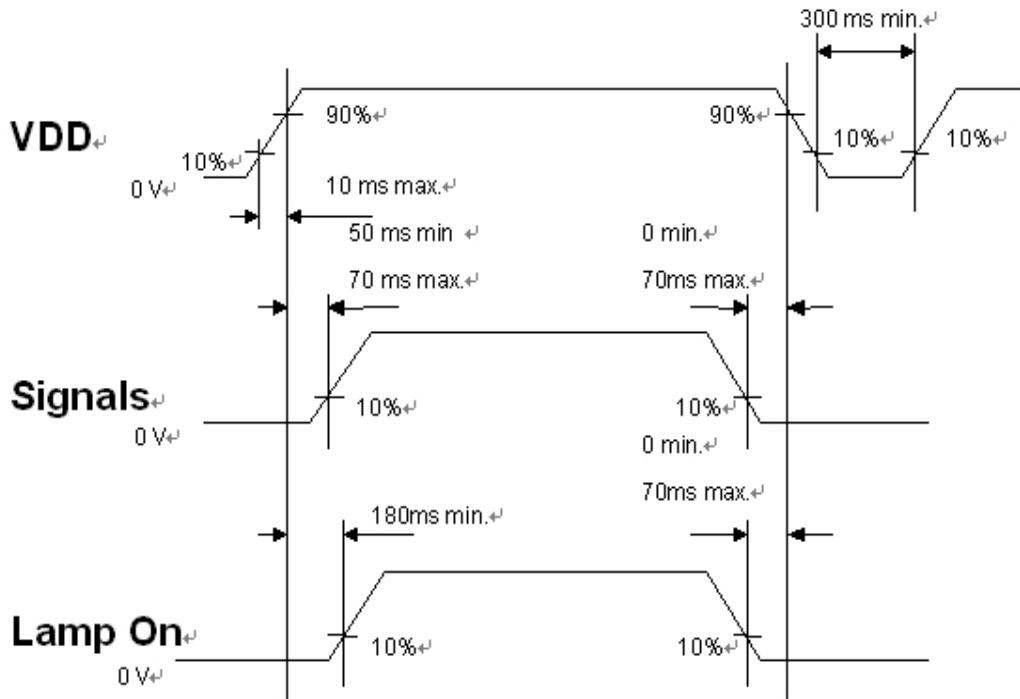

VDD power and lamp on/off sequence is as follows. Interface signals are also shown in the chart. Signals from any system shall be Hi-Z state or low level when VDD is off.



## 11.0 Reliability test items (Note 1)

Test tem	Test Condition	Remark
High temperature storage	60°C, 240Hrs	Note 1, 2, 3
Low temperature storage	-20°C, 240Hrs	Note 1, 2, 3
High temperature & high humidity operation	40°C, 90%RH, 240Hrs (No condensation)	Note 1, 2, 3
High temperature operation	50°C, 240Hrs	Note 1, 2, 3
Low temperature operation	0°C, 240Hrs	Note 1, 2, 3
Electrostatic discharge (non-operation)	150 pF, 150Ω, 10kV, 1 second, 9 position on the panel, 10 times each place	Note 3
Vibration (non-operation)	1.5G, 10Hz ~ 200Hz ~ 10Hz 30 minutes for each Axis (X, Y, Z)	Note 1, 2, 3
Mechanical shock (non-operation)	50G/20ms, ±X, ±Y, ±Z half-Sin, one time	Note 1, 2, 3
Thermal shock (non-operation)	1. -20°C±3°C...30minutes 60°C±3°C...30minutes 2. 100 cycles 3. Temperature transition time within 5 minutes	Note 1, 2, 3

**Note 1:** Evaluation should be tested after storage at room temperature for one hour.

**Note 2:** There should be no change which might affect the practical display function when the display quality test is conducted under normal operating condition.

**Note 3:** Judgement: 1. Function OK 2. No serious image quality degradation



## 12.0 Packing Dimension:

1. Max. Capacity: 30pcs LCD Modules / per carton
2. Max. Weight: TBD kg / per carton
3. The outside dimension of carton is 606(L) mm x 359(W) mm x 225(H) mm







### 13.0 Mechanical Characteristics (back side)

